

**SPECIFICATIONS IN INCHES**

**GENERAL**

Model No. SS \_\_\_\_\_ #14 gauge, type 304 stainless steel scullery sink. Compartments 14" deep. Square corner welded construction. Full length 8" high back-splash with 45° sloped top. 1-1/2" wide sloping top channel rims. Integral drain-board/s, sink compartments pitched to drain. Exposed surfaces polished to a satin finish.

Sinks supported on (4) LK251 stainless steel, 1-5/8" O.D. tubular legs, #16 gauge wall thickness. Adjustable bullet shaped feet.

- Shaded areas are models carried in stock with standard faucet location.
- Non-shaded areas with specified dimensions are standard models which must be made to order – standard faucet location unless otherwise specified.
- Last item in each group is custom. Fill in dimensions. Standard faucet location unless otherwise specified. Drainboards over 25-1/2" furnished with one tubular leg. Drainboards over 48" furnished with two tubular legs.

**SPECIFIED FITTINGS:**

SUPPLY:

DRAIN:

**FURNISHED WITH:**

LK251. (Four) Stainless steel tubular legs, 1-5/8" O.D., #16 gauge. Adjustable bullet shaped feet.

(CHECK MODEL SPECIFIED):  
**NO DRAINBOARD**

Model Number	Dimensions	
	A	B
SS8230	33	15
SS8236	39	18
SS8242	45	21
SS8248	51	24
SS8254	57	27
SS8260	63	30
• SSC8200		

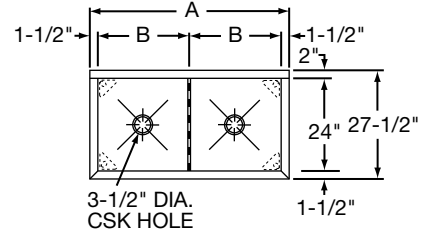

**RIGHT DRAINBOARD**

Model Number	Dimensions		
	A	B	C
SS8230R	55 1/2	15	24
SS8236R	61 1/2	18	24
SS8248R	73 1/2	24	24
SS8254R	79 1/2	27	24
SS8260R	85 1/2	30	24
• SSC8200R			

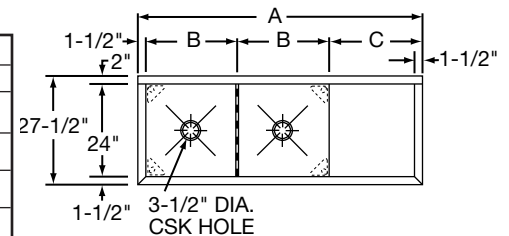

**LEFT DRAINBOARD**

Model Number	Dimensions		
	A	B	C
SS8230L	55 1/2	15	24
SS8236L	61 1/2	18	24
SS8248L	73 1/2	24	24
SS8254L	79 1/2	27	24
SS8260L	85 1/2	30	24
• SSC8200L			

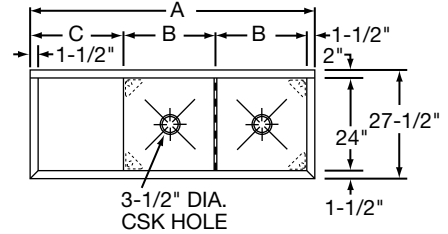

**RIGHT & LEFT DRAINBOARD**

Model Number	Dimensions		
	A	B	C
SS8230LR	78	15	24
SS8236LR	84	18	24
SS8248LR	96	24	24
SS8254LR	102	27	24
SS8260LR	108	30	24
• SSC8200LR			

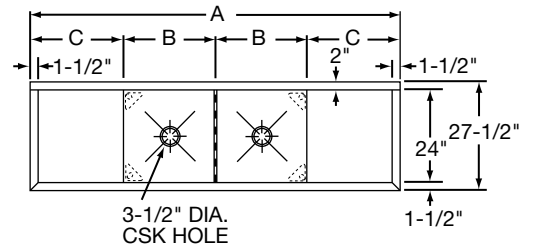

1-1/2" DIA. 2 HOLES

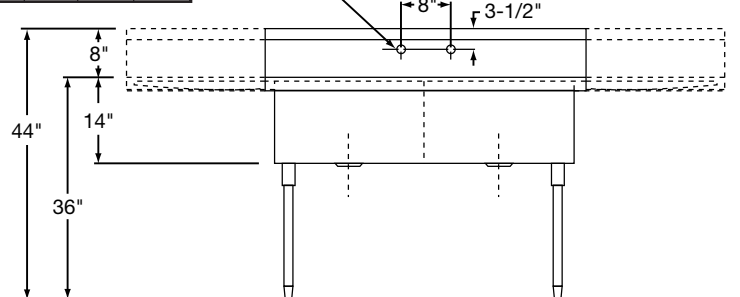

**FAUCET DRILLINGS AND LOCATION STANDARD AS ILLUSTRATED. (NON-STANDARD FAUCET AND OVERFLOW DRILLING LOCATIONS ARE AVAILABLE. SPECIFY ON DRAWING AT RIGHT.)**



ALL DIMENSIONS IN INCHES.  
SEE OTHER SIDE FOR DIMENSIONS IN MILLIMETERS.

**SPECIFICATIONS IN MILLIMETERS**

**GENERAL**

Model No. SS \_\_\_\_\_ #14 gauge, type 304 stainless steel scullery sink. Compartments 356mm deep. Square corner welded construction. Full length 203mm high backsplash with 45° sloped top. 38mm wide sloping top channel rims. Integral drainboard/s, sink compartments pitched to drain. Exposed surfaces polished to a satin finish.

Sinks supported on (4) LK251 stainless steel, 41mm O.D. tubular legs, #16 gauge wall thickness. Adjustable bullet shaped feet.

-  Shaded areas are models carried in stock with standard faucet location.
-  Non-shaded areas with specified dimensions are standard models which must be made to order – standard faucet location unless otherwise specified.
-  Last item in each group is custom. Fill in dimensions. Standard faucet location unless otherwise specified. Drainboards over 648mm furnished with one tubular leg. Drainboards over 1,219mm furnished with two tubular legs.

**SPECIFIED FITTINGS:**

SUPPLY:

DRAIN:

**FURNISHED WITH:**

LK251. (Four) Stainless steel tubular legs, 41mm O.D., #16 gauge. Adjustable bullet feet.

(CHECK MODEL SPECIFIED):  
**NO DRAINBOARD**

Model Number	Dimensions	
	A	B
SS8230	838	381
SS8236	991	457
SS8242	1143	533
SS8248	1295	610
SS8254	1448	686
SS8260	1600	762
• SSC8200		

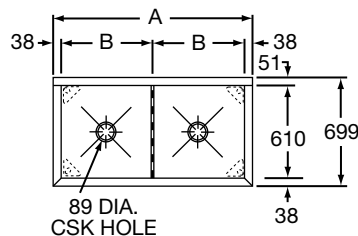

**RIGHT DRAINBOARD**

Model Number	Dimensions		
	A	B	C
SS8230R	1410	381	610
SS8236R	1562	457	610
SS8248R	1867	610	610
SS8254R	2019	686	610
SS8260R	2172	762	610
• SSC8200R			

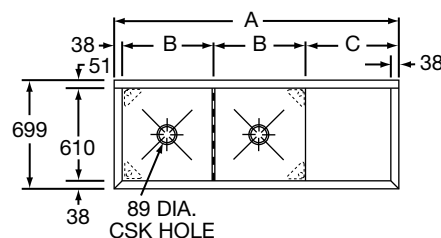

**LEFT DRAINBOARD**

Model Number	Dimensions		
	A	B	C
SS8230L	1410	381	610
SS8236L	1562	457	610
SS8248L	1867	610	610
SS8254L	2019	686	610
SS8260L	2172	762	610
• SSC8200L			

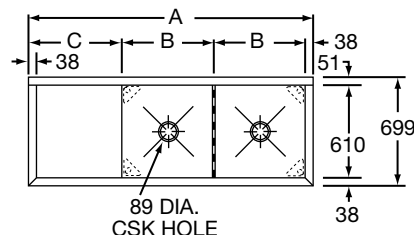

**RIGHT & LEFT DRAINBOARD**

Model Number	Dimensions		
	A	B	C
SS8230LR	1981	381	610
SS8236LR	2134	457	610
SS8248LR	2438	610	610
SS8254LR	2591	686	610
SS8260LR	2743	762	610
• SSC8200LR			

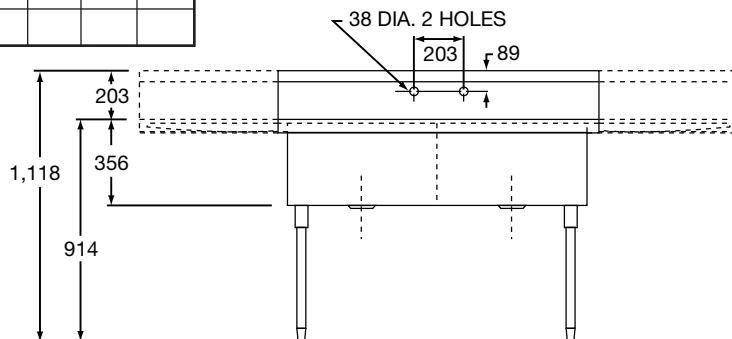
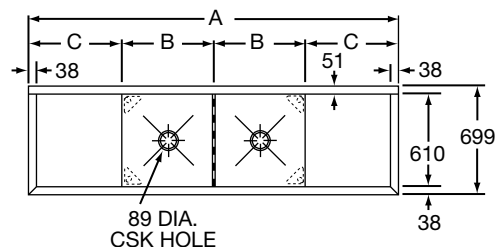

**FAUCET DRILLINGS AND LOCATION STANDARD AS ILLUSTRATED. (NON-STANDARD FAUCET AND OVERFLOW DRILLING LOCATIONS ARE AVAILABLE. SPECIFY ON DRAWING AT RIGHT.)**

ALL DIMENSIONS IN MILLIMETERS.  
 SEE OTHER SIDE FOR DIMENSIONS IN INCHES.