

LAVATORY FAUCET **K-8215-K** ALSO K-8215

FEATURES

- Brass construction
- Flexible connections
- Brass valve bodies
- Quarter-turn washerless ceramic disc valves
- 5" high-arch spout
- 2.0 gallons per minute
- Pop-up drain with lift rod and tailpiece
- Variety of handle style options

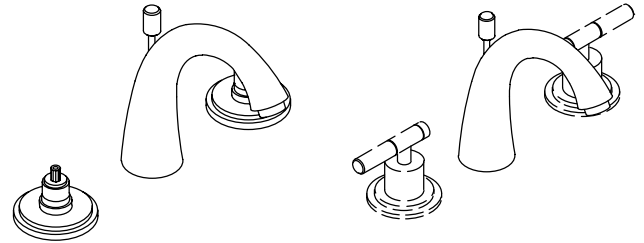

CODES/STANDARDS APPLICABLE

Specified model meets or exceeds the following:

- ASME/ANSI A112.18.1M
- Energy Policy Act of 1992
- NSF 61

K-8215-K





K-8215

COLORS/FINISHES



- CP Polished Chrome
- PB Polished Brass
- Other Refer to Faucets Price Book for additional finishes

SPECIFIED MODEL:

BASE FAUCET: For complete faucet, both base faucet and handle choice must be specified.

K-8215-K	Taboret Widespread Lavatory Base Faucet	<input type="checkbox"/> CP	<input type="checkbox"/> PB			
Required Accessory (Includes Two Handles)			 ADA	 ADA	 ADA	 ADA
K-16070-2	Square Handles	<input type="checkbox"/> CP <input type="checkbox"/> PB				
K-16070-4	Lever Handles		<input type="checkbox"/> CP <input type="checkbox"/> PB			
K-16070-4A	Swirl Lever Handles			<input type="checkbox"/> CP <input type="checkbox"/> PB		
K-16070-4C	Vandal-Proof Lever Handles, Aerator		<input type="checkbox"/> CP			
K-16070-6	T-Handles				<input type="checkbox"/> CP <input type="checkbox"/> PB	
K-16070-6C	Vandal-Proof T-Handles, Aerator				<input type="checkbox"/> CP	

COMPLETE FAUCET: Faucet handles included.

Variations		 ADA	 ADA
K-8215-4	With Lever Handles	<input type="checkbox"/> Other_____	
K-8215-6	With T-Handles		<input type="checkbox"/> Other_____

PRODUCT SPECIFICATION:

Two-handle widespread lavatory faucet shall be of brass construction. Faucet shall feature brass valve bodies. Faucet shall feature quarter-turn washerless ceramic disc valves, assuring positive handle stop positioning. Product shall include 5" high-arch spout, pop-up drain with lift rod and tailpiece, and handles. Base faucet shall be Kohler Model K-8215-K-_____ with K-_____ - _____ handles **OR** complete faucet shall be Kohler Model K-8215-_____ - _____.

TABORET®

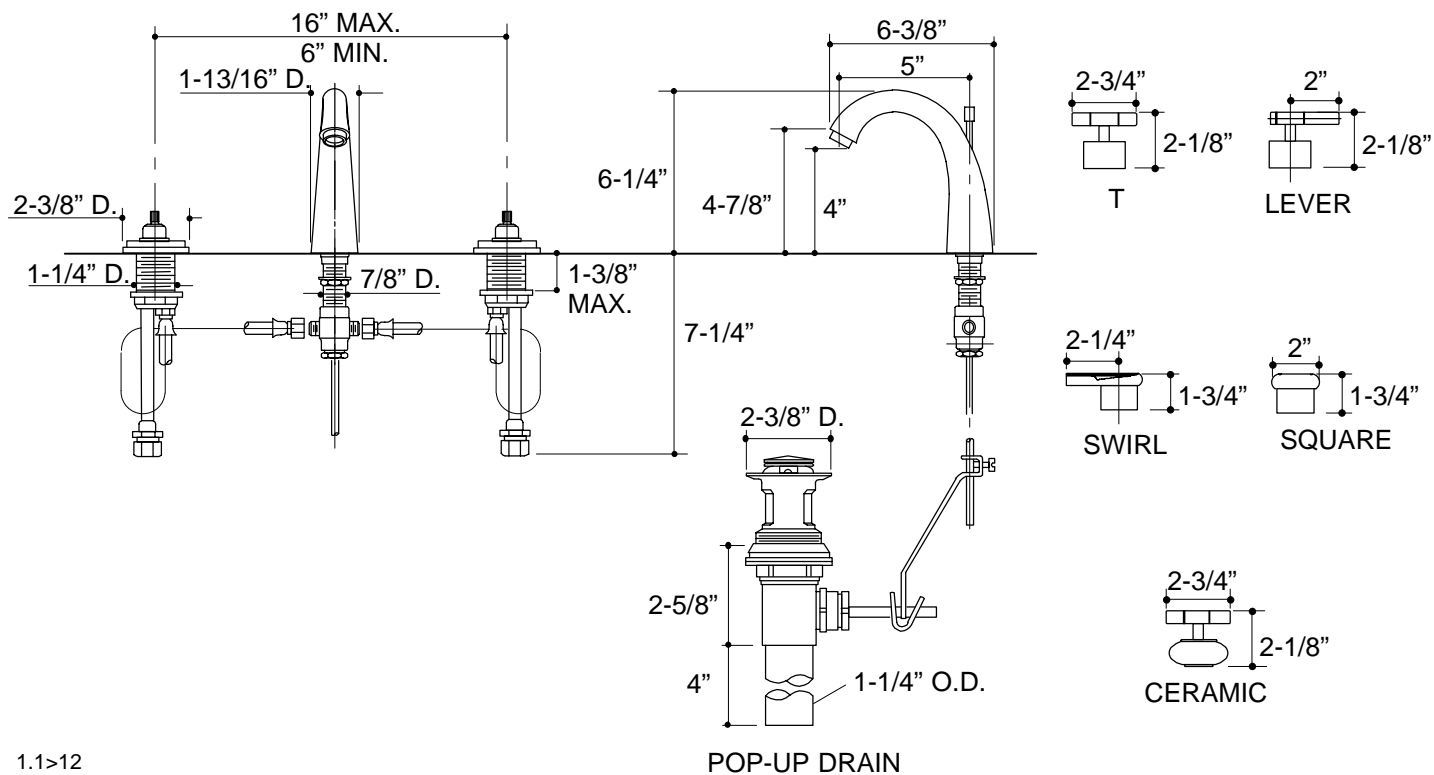

1.1>12

PRODUCT DIAGRAM