

For Health Hazard Applications

Job Name _____

Contractor _____

Job Location _____

Approval _____

Engineer _____

Contractor's P.O. No. _____

Approval _____

Representative _____

Series 009

Reduced Pressure Zone Assemblies

Sizes: 1/4" – 3" (8 – 80mm)

Series 009 Reduced Pressure Zone Assemblies are designed to protect potable water supplies in accordance with national plumbing codes and water authority requirements. This series can be used in a variety of installations, including the prevention of health hazard cross connections in piping systems or for containment at the service line entrance.

This series features two in-line, independent check valves, captured springs and replaceable check seats with an intermediate relief valve. Its compact modular design facilitates easy maintenance and assembly access. Sizes 1/4" – 1" (8 – 25mm) shutoffs have tee handles.

Features

- Single access cover and modular check construction for ease of maintenance
- Top entry - all internals immediately accessible
- Captured springs for safe maintenance
- Internal relief valve for reduced installation clearances
- Replaceable seats for economical repair
- Bronze body construction for durability 1/4" – 2" (8 – 50mm)
- Fused epoxy coated cast iron body 2 1/2" and 3" (65 and 80mm)
- Ball valve test cocks — screwdriver slotted 1/4" – 2" (8 – 50mm)
- Large body passages provides low pressure drop
- Compact, space saving design
- No special tools required for servicing

Specifications

A Reduced Pressure Zone Assembly shall be installed at each potential health hazard location to prevent backflow due to backsiphonage and/or backpressure. The assembly shall consist of an internal pressure differential relief valve located in a zone between two positive seating check modules with captured springs and silicone seat discs. Seats and seat discs shall be replaceable in both check modules and the relief valve. There shall be no threads or screws in the waterway exposed to line fluids. Service of all internal components shall be through a single access cover secured with stainless steel bolts. The assembly shall also include two resilient seated isolation valves, four resilient seated test cocks and an air gap drain fitting. The assembly shall meet the requirements of: USC Manual 8th Edition†; ASSE Std. 1013; AWWA Std. C511; CSA B64.4. Shall be a Watts Regulator Co. Series 009.

†Does not indicate approval status. Refer to Page 2 for approved sizes & models.

Watts product specifications in U.S. customary units and metric are approximate and are provided for reference only. For precise measurements, please contact Watts Technical Service. Watts reserves the right to change or modify product design, construction, specifications, or materials without prior notice and without incurring any obligation to make such changes and modifications on Watts products previously or subsequently sold.

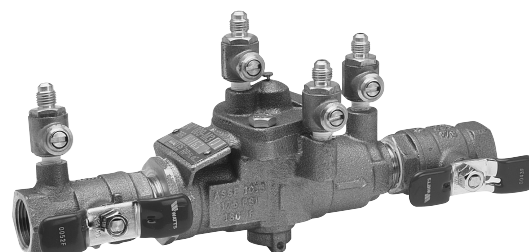

1/2" 009QT

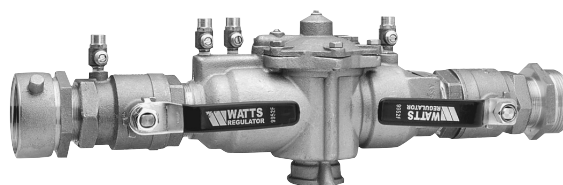

2" 009M2QTHC

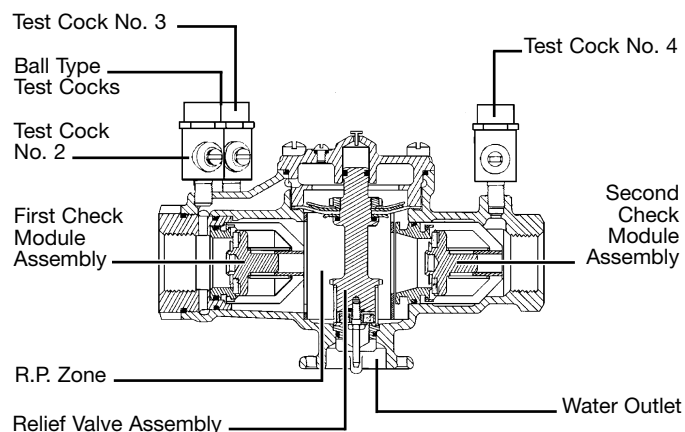

Now Available
WattsBox Insulated Enclosures.

For more information, send for literature ES-WB.

**IMPORTANT: INQUIRE WITH GOVERNING AUTHORITIES
FOR LOCAL INSTALLATION REQUIREMENTS**

ISO 9001
CERTIFIED

WATTS®
REGULATOR

USA: 815 Chestnut St., No. Andover, MA 01845-6098; www.wattsreg.com

Canada: 5435 North Service Rd., Burlington, ONT L7L 5H7; www.wattscanada.ca

Available Models: 1/4" – 2" (8 – 50mm)

Suffix:

- QT – quarter-turn ball valves
- S – bronze strainer
- LF – without shutoff valves
- AQT – elbow fittings for 360° rotation
3/4" – 2" (20 – 50mm) only
- PC – internal Polymer Coating
- LH – locking handle ball valves (open position)
- SH – stainless steel ball valve handles
- HC – 2 1/2" inlet/outlet fire hydrant fitting (2" valve)

Prefix:

- C – clean and check strainer
3/4" – 1" (20 – 25mm) only
- U – union connections (see ES-U009)

Available Models: 2 1/2" – 3" (65 – 80mm)

Suffix:

- NRS – non-rising stem resilient seated gate valves
- OSY – UL/FM outside stem and yoke resilient seated gate valves
- S-FDA – FDA epoxy coated strainer
- QT-FDA – FDA epoxy coated quarter-turn ball valve shutoffs
- LF – without shutoff valves
- S – cast iron strainer

Note: The installation of a drain line is recommended. When installing a drain line, an air gap is necessary (see ES-AG).

Materials: 1/4" – 2" (8 – 50mm)

Bronze body construction, silicone rubber disc material in the first and second check plus the relief valve. Replaceable polymer check seats for first and second checks. Removable stainless steel relief valve seat. Stainless steel cover bolts.

Standardly furnished with NPT body connections. For optional bronze union inlet and outlet connections, specify prefix U (1/2" – 2"(15 – 50mm)). Series 009QT furnished with quarter turn, full port, resilient seated, bronze ball valve shutoffs.

Air Gaps and Elbows

MODEL	DRAIN OUTLET	DIMENSIONS				WEIGHT			
		A		B					
	for 909, 009 and 993 sizes	in.	mm	in.	mm	in.	mm	lbs.	kgs.
909AG-A	1/4"-1/2" 009, 3/4" 009M2/M3	1/2	13	2 3/8	60	3 1/8	79	.625	.28
909AG-C	3/4"-1" 009/909, 1"-1 1/2" 009M2	1	25	3 1/4	83	4 7/8	124	1.50	.68
909AG-F	1 1/4"-2" 009M1, 1 1/4"-3" 009/909, 2" 009M2, 4"-6" 993	2	51	4 3/8	111	6 3/4	171	3.25	1.47
909AG-K	4"-6" 909, 8"-10" 909M1	3	76	6 3/8	162	9 5/8	243	6.25	2.83
909AG-M	8"-10" 909	4	102	7 3/8	187	11 1/4	394	15.50	7.03
909EL-A	1/4"-1/2" 009, 3/4" 009M2/M3	-	-	-	-	-	-	-	-
909EL-C	3/4"-1" 009/909	-	-	2 3/8	60	2 3/8	60	.38	.17
* 909EL-F	1 1/4"-2" 009M1, 1 1/4"-2" 009/909, 2" 009M2, 4"-6" 993	-	-	3 5/8	92	3 5/8	92	2	.91
* 909EL-H Vertical	2 1/2"-3" 009/909	-	-	-	-	-	-	-	-

Materials: 2 1/2" and 3" (65 – 80mm)

- (FDA approved) Epoxy coated cast iron unibody with bronze seats
- Relief valve with stainless steel seat and trim
- Bronze body ball valve test cocks

Pressure / Temperature

Series 009 1/4" – 2" (8 – 50mm) Suitable for supply pressure up to 175psi (12 bar). Water temperature: 33°F – 180°F (-3°C – 75°C).

Sizes 2 1/2" and 3" (65 and 80mm) are suitable for supply pressures up to 175psi (12 bar) and water temperature at 110°F (43°C) continuous, 140°F (60°C) intermittent.

Standards

- USC Manual 8th Edition†
- ASSE No. 1013
- AWWA C511-92
- CSA B64.4
- IAPMO File No. 1563.

†Does not indicate approval status. See below for approved models.



Approvals

ASSE, AWWA, CSA, IAPMO

Approved by the Foundation for Cross-Connection Control and Hydraulic Research at the University of Southern California.

Approval models QT, AQT, PC, NRS, OSY.

UL Classified 3/4" – 2" (20 – 50mm) (LF models only)

2 1/2" and 3" (65 and 80mm) with OSY gate valves.

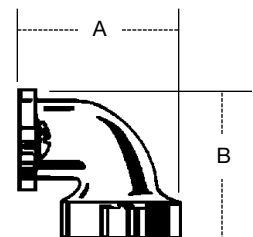
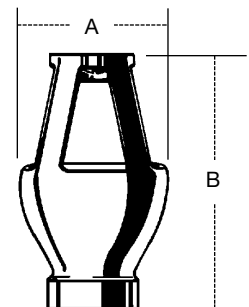

Dimensions and Weight: 1/4" – 2" (8 – 50mm) 009

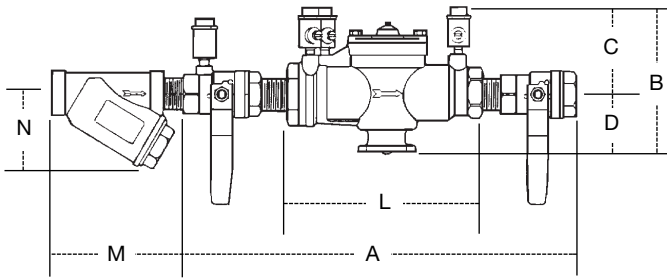

Suffix HC – Fire Hydrant Fittings dimension 'A' = 25" (637mm)
009 1/4" – 2"

SIZE (DN)		DIMENSIONS (APPROX.)										STRAINER DIMENSIONS				WEIGHT	
in.	mm	A		B		C		D		L		M		N		lbs.	kg.
		in.	mm	in.	mm	in.	mm	in.	mm	in.	mm	in.	mm	in.	mm		
1/4	8	10	250	4 5/8	117	3 3/8	86	1 1/4	32	5 1/2	140	2 3/8	60	2 1/2	64	5	2
3/8	10	10	250	4 5/8	117	3 3/8	86	1 1/4	32	5 1/2	140	2 3/8	60	2 1/2	64	5	2
1/2	15	10	250	4 5/8	117	3 3/8	86	1 1/4	32	5 1/2	140	2 3/4	70	2 1/4	57	5	2
3/4	20	10 3/4	273	5	127	3 1/2	89	1 1/2	38	6 3/4	171	3 3/16	81	2 3/4	70	6	3
1	25	16 3/4	425	5 1/2	140	3	76	2 1/2	64	9 1/2	241	3 3/4	95	3	76	12	5
1 1/4	32	17 3/8	441	6	150	3 1/2	89	2 1/2	64	11 3/8	289	4 7/16	113	3 1/2	89	15	6
1 1/2	40	17 7/8	454	6	150	3 1/2	89	2 1/2	64	11 1/8	283	4 7/8	124	4	102	16	7
2	50	21 1/8	543	7 3/4	197	4 1/2	114	3 1/4	83	13 1/2	343	5 15/16	151	5	127	30	13

Dimensions and Weight: 2 1/2" and 3" (65 and 80mm) 009

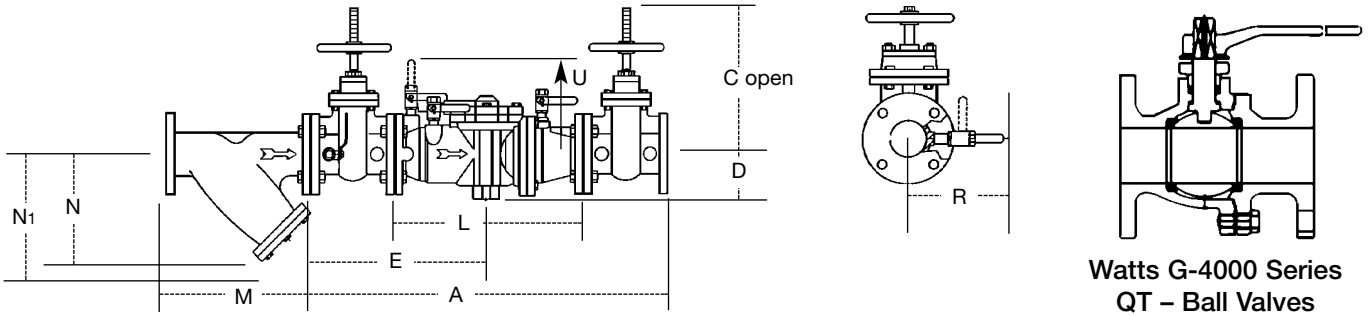

Watts G-4000 Series
QT – Ball Valves

STRAINER SIZE		DIMENSIONS (approx.)						WEIGHT	
in.	mm	M		N		N ₁ †		lbs.	kgs.
		in.	mm	in.	mm	in.	mm		
2 1/2	65	10	254	6 1/2	165	9 3/4	248	28	12.7
3	80	10 1/8	257	7	178	10	254	34	15.4

†Clearance for servicing

MODEL	SIZE DN		DIMENSIONS (APPROX.)										WEIGHT					
	in.	mm	A		C		D		E		L		R		U		lbs.	kgs.
			in.	mm	in.	mm	in.	mm	in.	mm	in.	mm	in.	mm	in.	mm		
009LF	2 1/2	65	—	—	—	—	4 1/2	114	—	—	18 1/8	460	—	—	10 5/8	270	76	34.5
0090SY	2 1/2	65	33 1/4	845	15 7/8	403	4 1/2	114	16 3/8	416	18 1/8	460	7 3/4	197	10 5/8	270	166	75.3
009NRS	2 1/2	65	33 1/4	845	11 3/8	289	4 1/2	114	16 3/8	416	18 1/8	460	7 3/4	197	10 5/8	270	161	73.0
009QT	2 1/2	65	33 1/4	845	6	152	4 1/2	114	16 3/8	416	18 1/8	460	7 3/4	197	10 5/8	270	150	68.0
009LF	3	80	—	—	—	—	4 1/2	114	—	—	18 1/8	460	—	—	10 5/8	270	76	34.5
0090SY	3	80	34 1/4	870	18 1/2	470	4 1/2	114	16 5/8	422	18 1/8	460	8 3/4	222	10 5/8	270	198	89.8
009NRS	3	80	34 1/4	870	12 3/4	324	4 1/2	114	16 5/8	422	18 1/8	460	8 3/4	222	10 5/8	270	191	86.6
009QT	3	80	34 1/4	870	7	178	4 1/2	114	16 5/8	422	18 1/8	460	8 3/4	222	10 5/8	270	158	71.7

Capacity

Performance as established by an independent testing laboratory.

*Typical maximum system flow rate (7.5 feet/sec., 2.3 meters/sec.)

